

Variable Length Sequences

N-gram features

Convolutional Networks

Yoav Goldberg

"feature embeddings"

- Each feature is assigned a vector.
- The input is a combination of feature vectors.
- The feature vectors are **parameters of the model** and are trained jointly with the rest of the network.
- **Representation Learning:** similar features will receive similar vectors.

"feature embeddings"

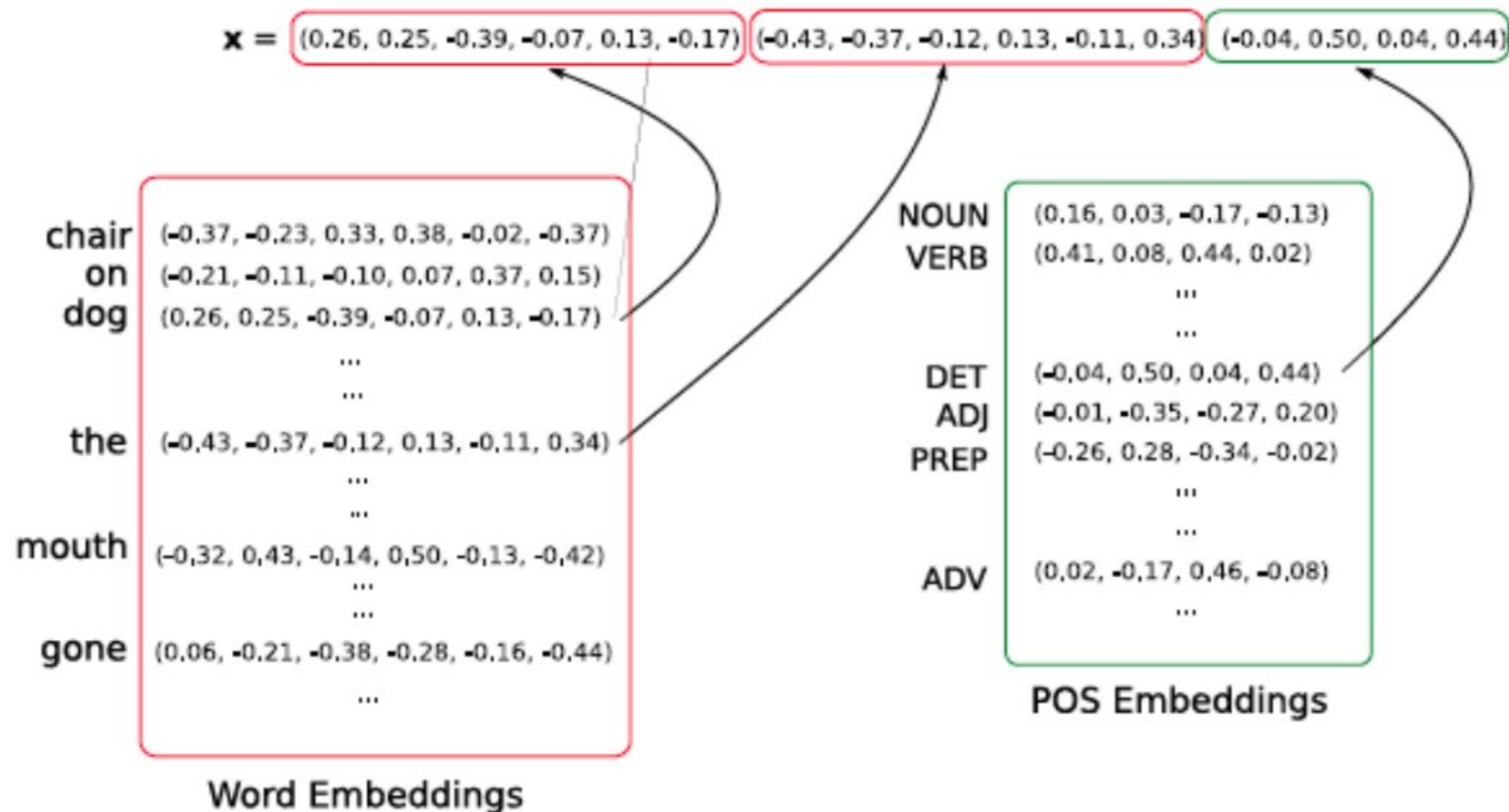
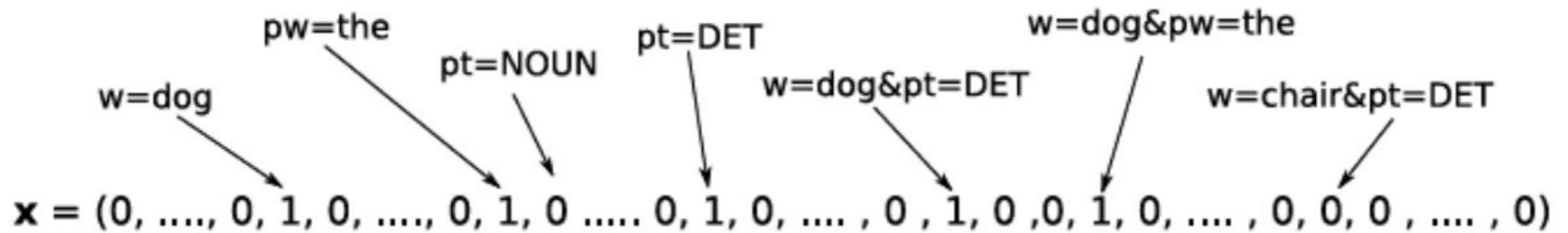

"feature embeddings"

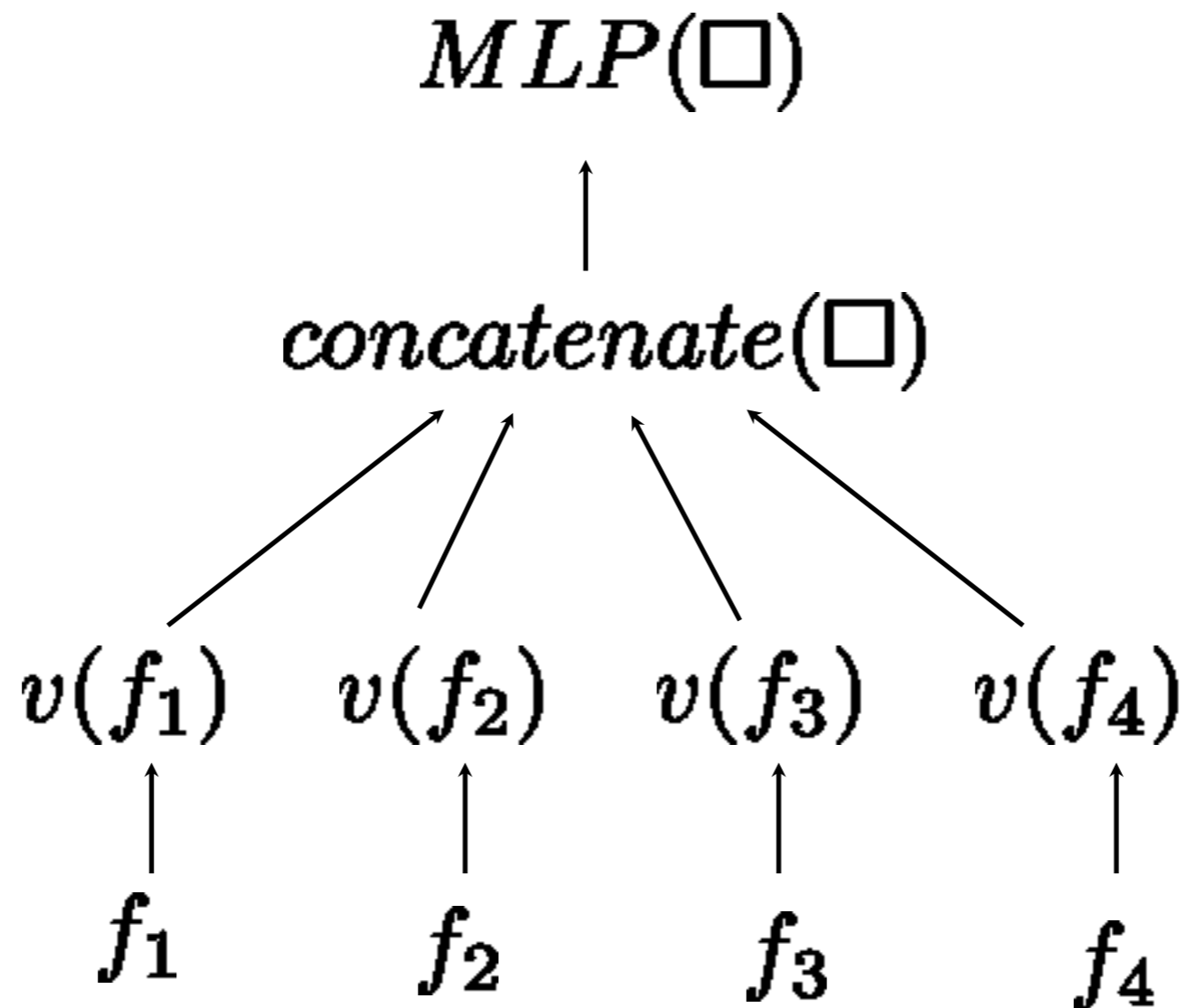

"feature embeddings"

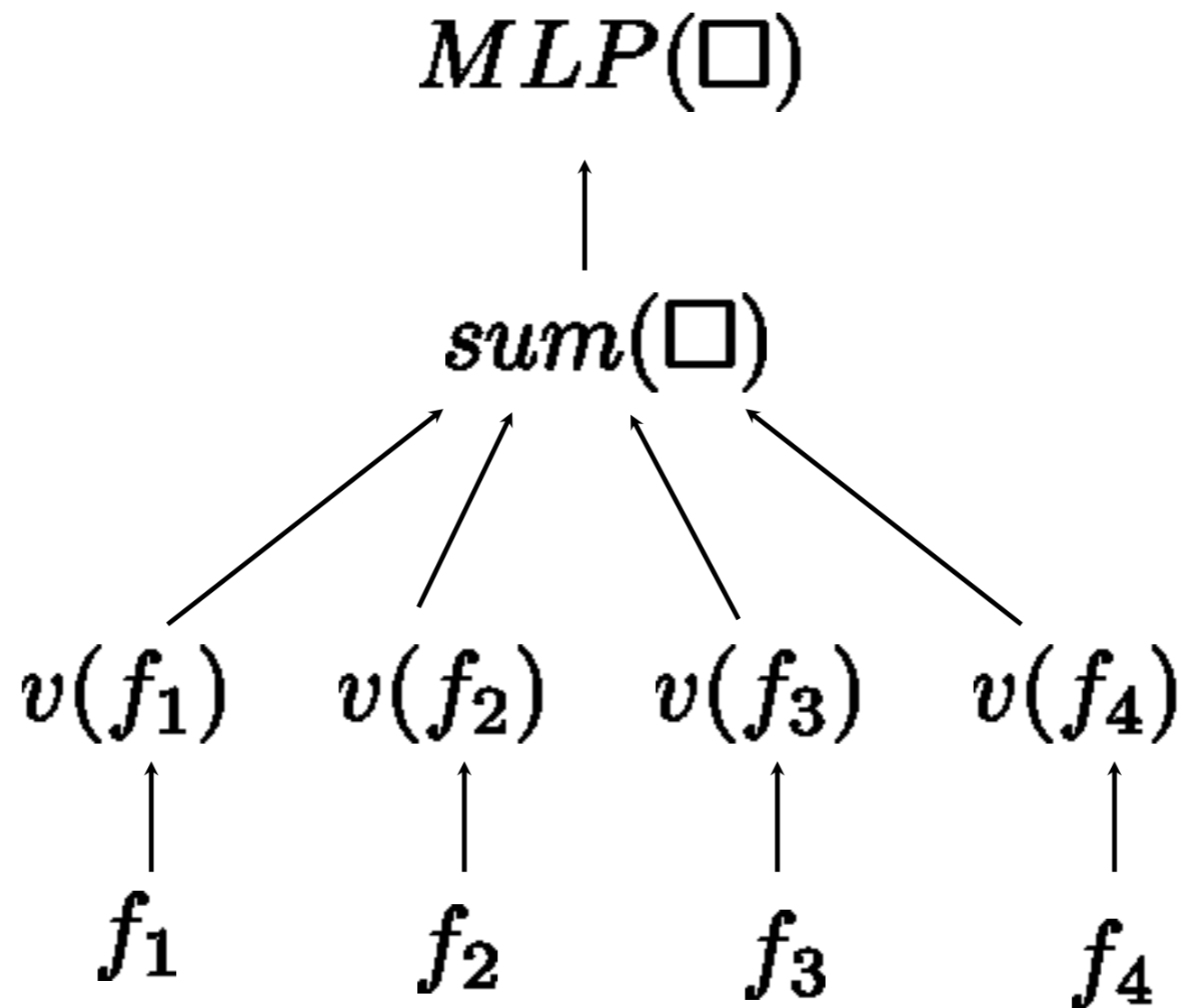

Concat vs. Sum

- **Concatenating** feature vectors: the "roles" of each vector is retained.

concat (v("the"), v("thirsty"), v("dog"))

prev
word

current
word

next
word

- Different features can have vectors of different dim.
- Fixed number of features in each example (need to feed into a fixed dim layer).

Concat vs. Sum

- **Summing** feature vectors: "bag of features"

$$\text{sum}(v(\text{"the"}), v(\text{"thirsty"}), v(\text{"dog"}))$$

word

word

word

- Different feature vectors should have same dim.
- Can encode arbitrary number of features.

Concat vs. Sum

- **Summing** feature vectors: "bag of features"

$$\text{sum}(v(\text{"the"}), v(\text{"thirsty"}), v(\text{"dog"}))$$

word

word

word

- Different feature vectors should have same dim.
- Can encode **arbitrary number of features.**

Continuous Bag of Words (CBOW)

$$CBOW(f_1, \dots, f_k) = \frac{1}{k} \sum_{i=1}^k v(f_i)$$

- a popular choice in document classification.
- can assign a different weight to each feature:

$$WCBOW(f_1, \dots, f_k) = \frac{1}{\sum_{i=1}^k a_i} \sum_{i=1}^k a_i v(f_i)$$

Surprising Power of CBOW

$$CBOW(f_1, \dots, f_k) = \frac{1}{k} \sum_{i=1}^k v(f_i)$$

Given CBOW vector and word vector,
can we predict if word is in cbow?

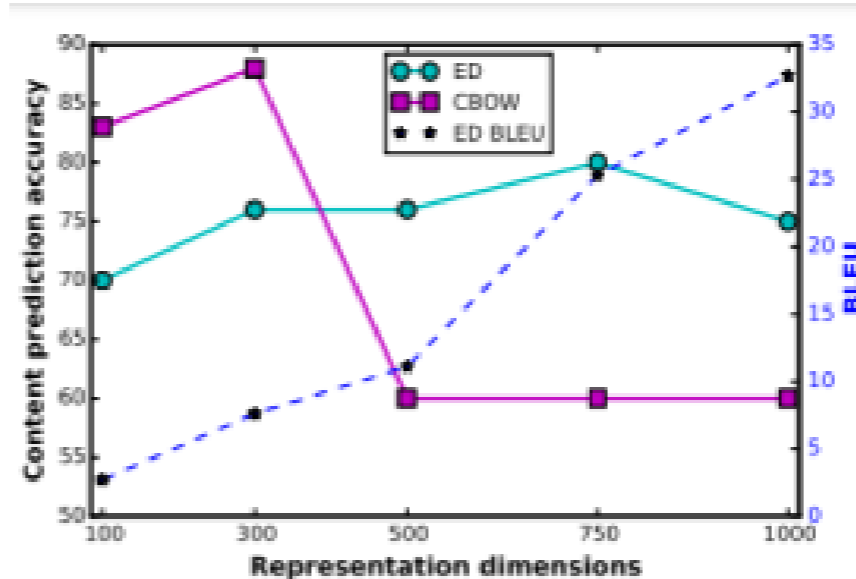

FINE-GRAINED ANALYSIS OF SENTENCE
EMBEDDINGS USING AUXILIARY PREDICTION TASKS

Surprising Power of CBOW

$$CBOW(f_1, \dots, f_k) = \frac{1}{k} \sum_{i=1}^k v(f_i)$$

Given CBOW vector and two word vectors, can we predict which word appeared before the other?

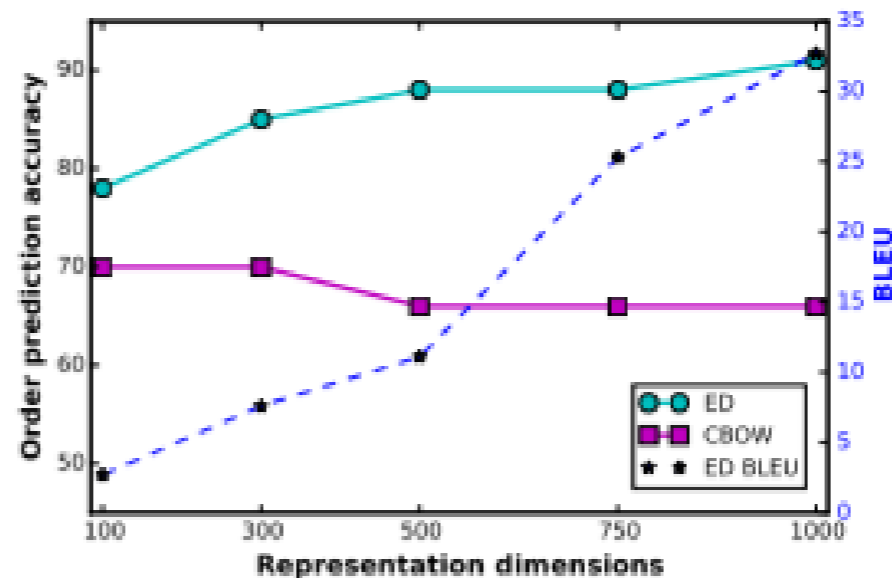

FINE-GRAINED ANALYSIS OF SENTENCE
EMBEDDINGS USING AUXILIARY PREDICTION TASKS

Surprising Power of CBOW

$$CBOW(f_1, \dots, f_k) = \frac{1}{k} \sum_{i=1}^k v(f_i)$$

Given CBOW vector
can we predict sentence length?

FINE-GRAINED ANALYSIS OF SENTENCE
EMBEDDINGS USING AUXILIARY PREDICTION TASKS

Surprising Power of CBOW

$$CBOW(f_1, \dots, f_k) = \frac{1}{k} \sum_{i=1}^k v(f_i)$$

Given CBOW vector
can we predict sentence length?

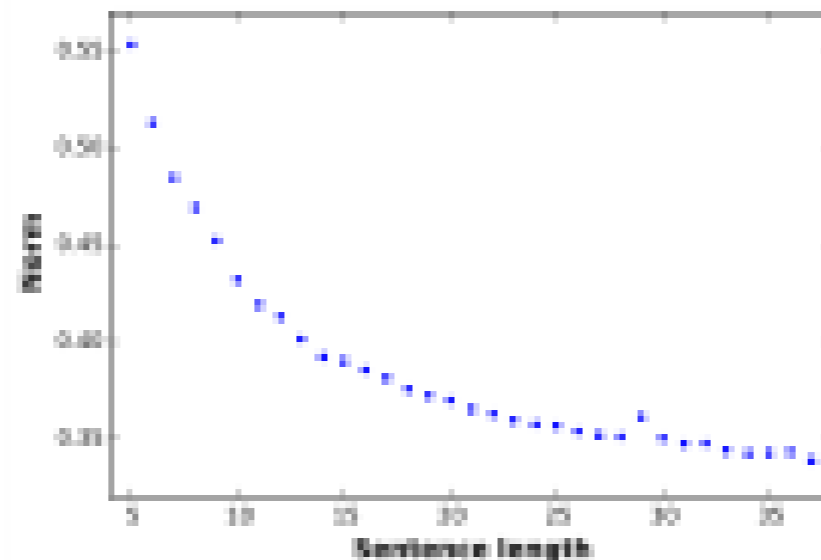

how come?

(b) Average embedding norm vs. sentence length for CBOW with an embedding size of 300.

Deep Unordered Composition Rivals Syntactic Methods for Text Classification

Mohit Iyyer,¹ Varun Manjunatha,¹ Jordan Boyd-Graber,² Hal Durrant III¹

¹University of Maryland, Department of Computer Science and UMLACS

²University of Colorado, Department of Computer Science

{miiyer, varunm, hal}@umlacs.umd.edu, Jordan.Boyd.Grabar@colorado.edu

"Document Averaging Networks"

text classification

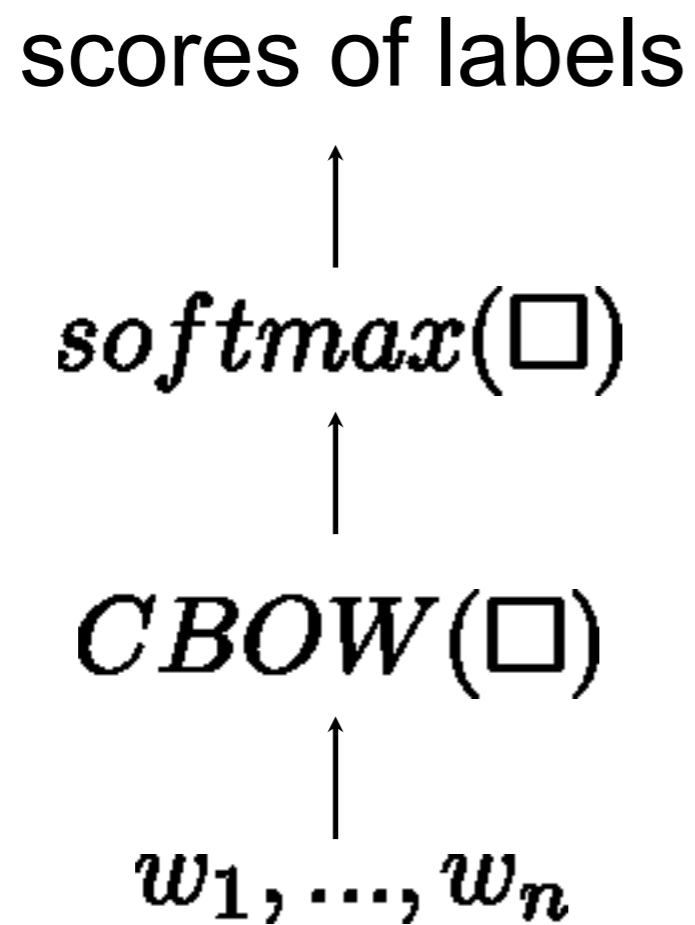

"neural bag of words"

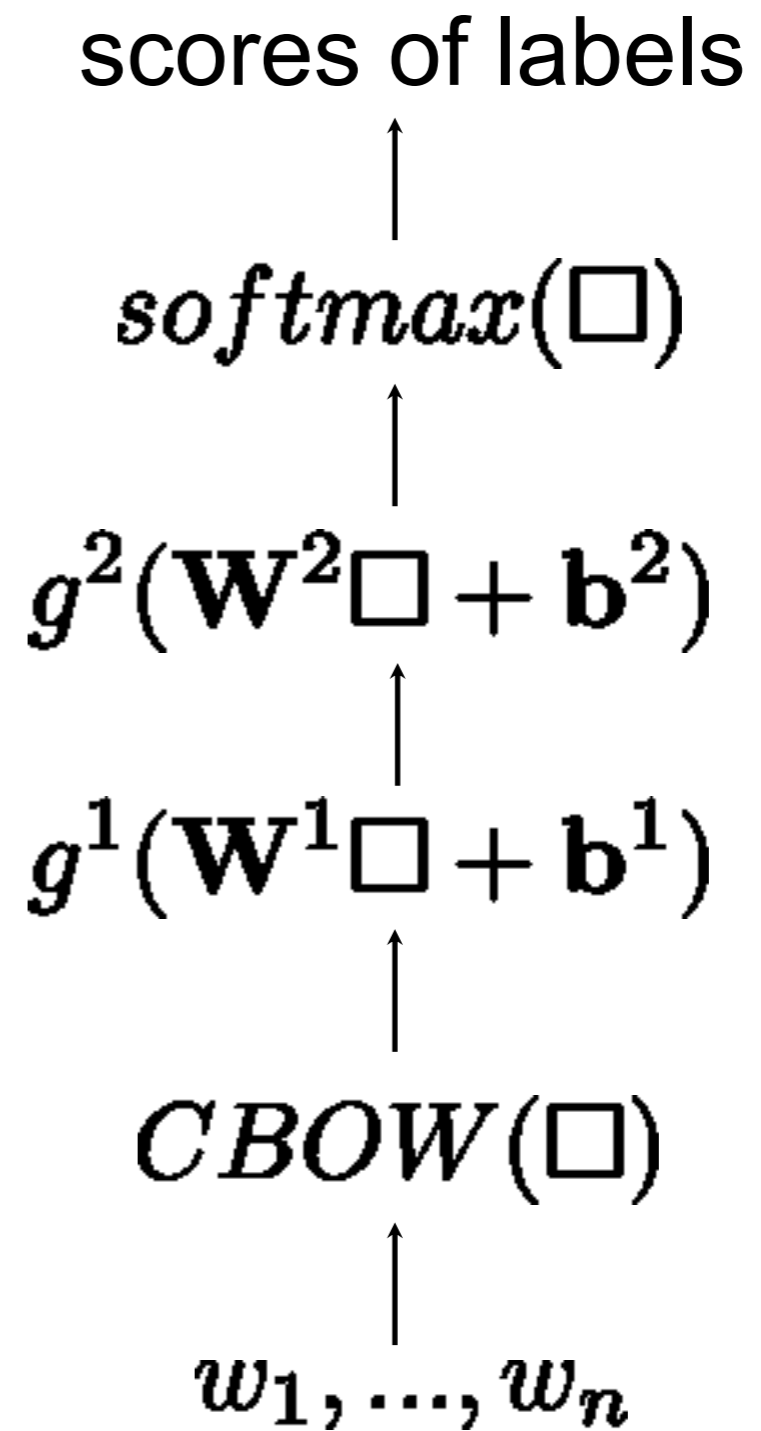

"deep averaging network"

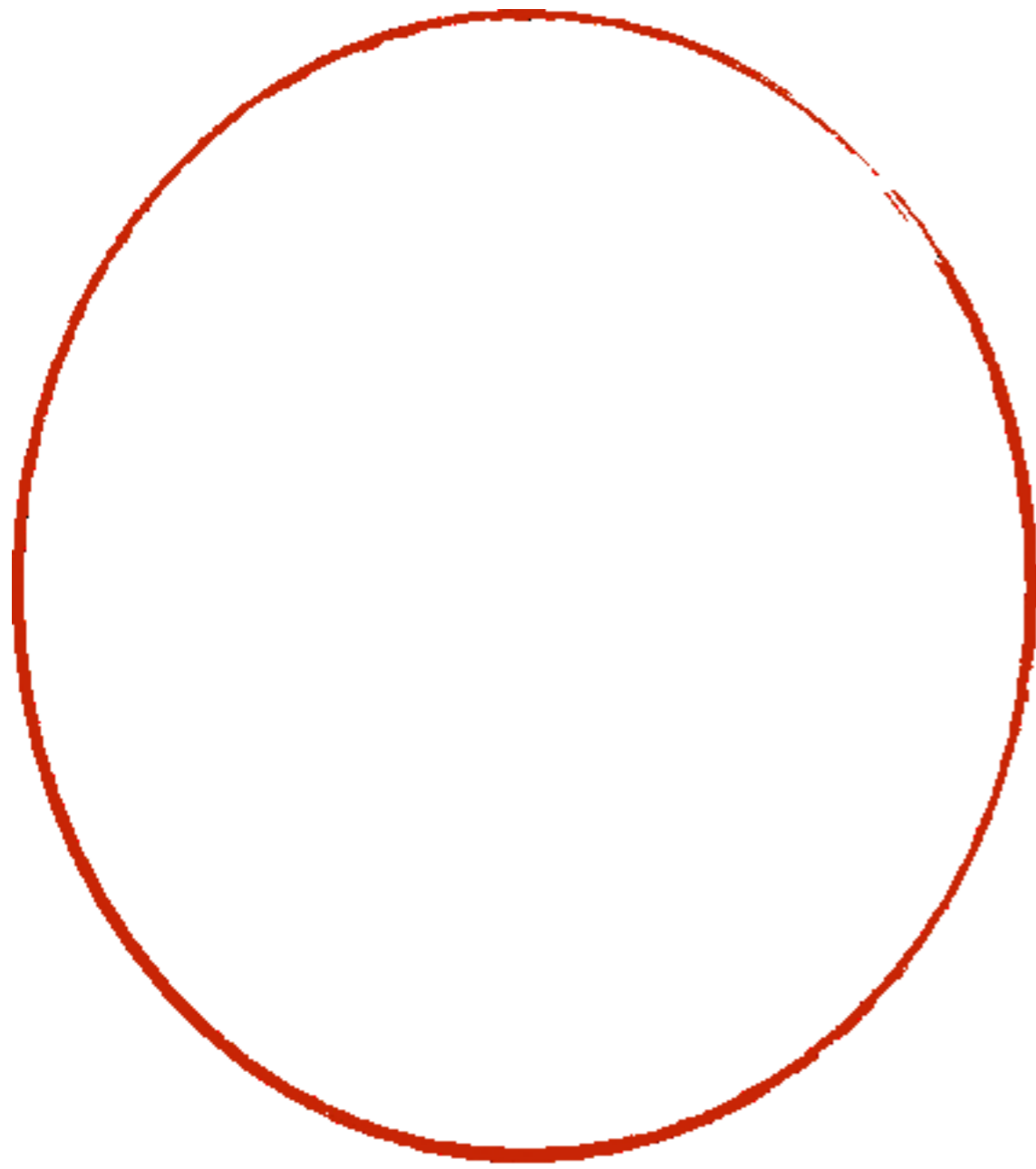

"neural bag of words"

If each feature is bigram,
works great.

Moving to unigrams, large drop.

Unigrams + MLP --> better
but not like bigrams.

Importance of Ngrams

- While we can ignore global order in many cases...
- ... local ordering is still often very important.
- Local sub-sequences encode useful structures.

Importance of Ngrams

- While we can ignore global order in many cases...
- ... local ordering is still often very important.
- Local sub-sequences encode useful structures.

(so why not just assign a vector to each ngram?)

ConvNets

special architecture for local predictors

ConvNets

- CBOW allows encoding arbitrary length sequences, but loses all order information.
- Some local order (i.e. bigrams, trigrams) is informative. Yet, we do not care about exact position in the sequence. (think "good" vs. "not good")
- ConvNets (in language) allow to identify informative local predictors.
- Works by moving a shared function (feature extractor) over a sliding window, then pooling results.

ConvNets

- ConvNets have huge success in computer vision.
- It allows invariance to object position.
- It allows composing large predictors from small.

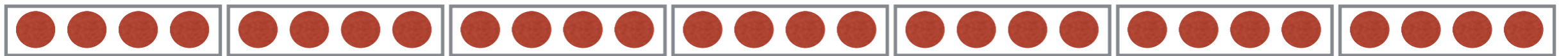

the actual service was not very good



dot

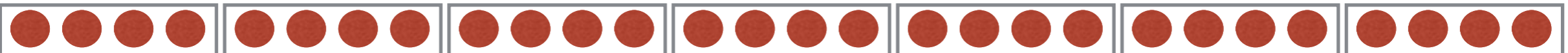

the

actual

service

was

not

very

good



||



dot

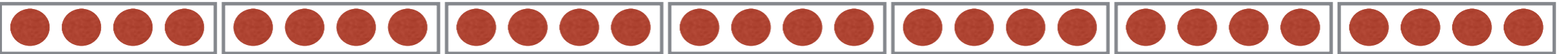

the

actual

service

was

not

very

good

the actual



||



dot

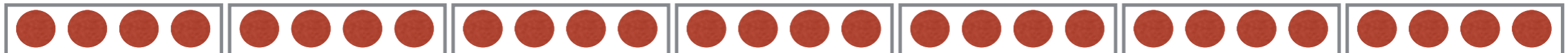

the actual service was not very good

the actual

actual service



||



dot

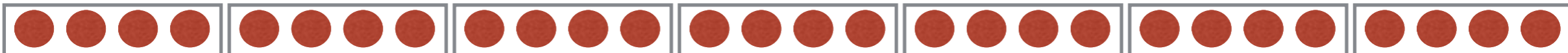

the

actual

service

was

not

very

good

the actual

actual service

service was



||

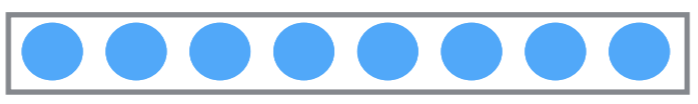

dot

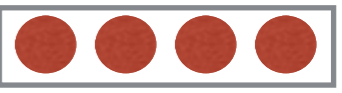
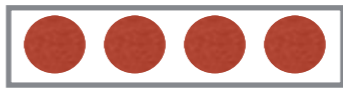
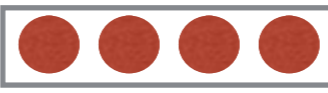
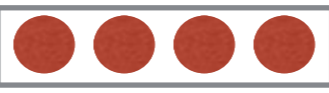
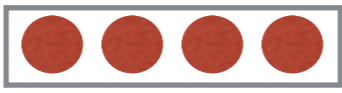
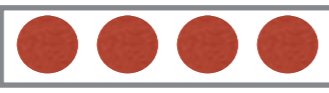
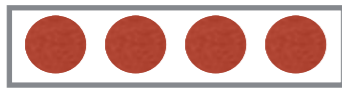

the

actual

service

was

not

very

good

the actual

actual service

service was

was not



||



dot

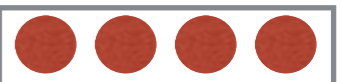
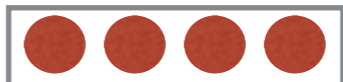
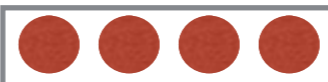
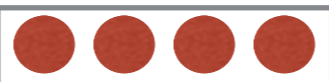
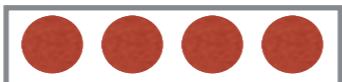
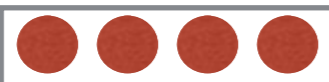
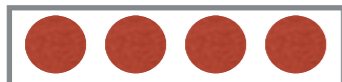

the

actual

service

was

not

very

good

the actual

actual service

service was

was not

not very



||



dot

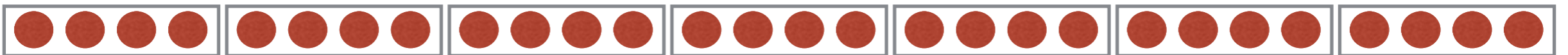

the

actual

service

was

not

very

good

the actual

actual service

service was

was not

not very

very good



||

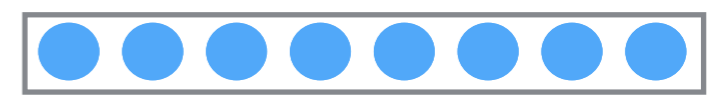

dot

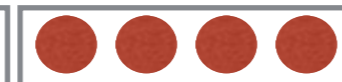
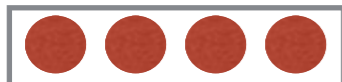

the

actual

service

was

not

very

good

the actual



||

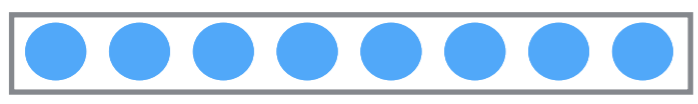

dot

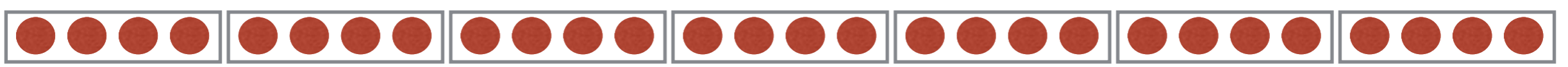

the actual service was not very good

the actual



||

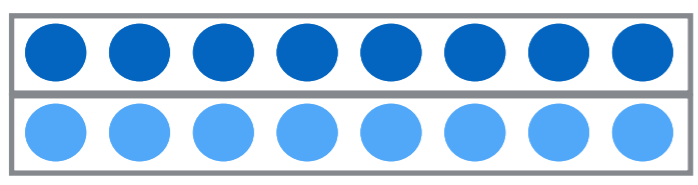

dot

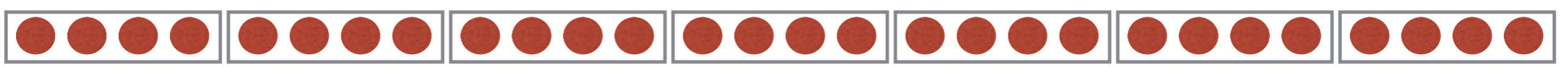

the actual service was not very good

the actual



||

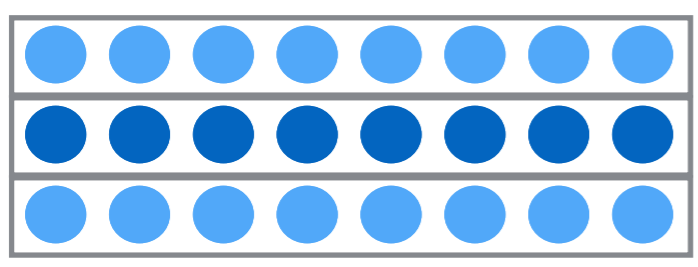

dot

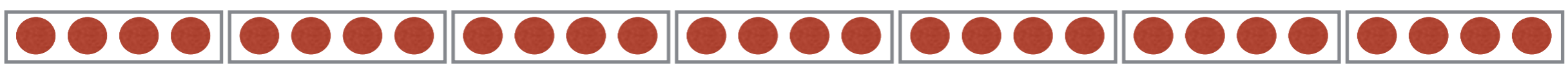

the actual service was not very good

the actual



actual service



||

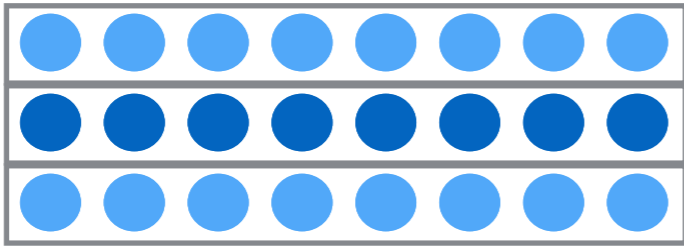

dot

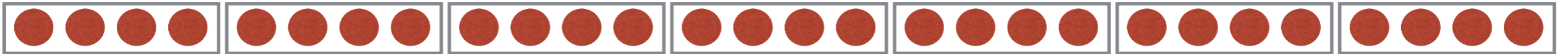

the

actual

service

was

not

very

good

the actual



actual service



service was



was not



not very



very good



||

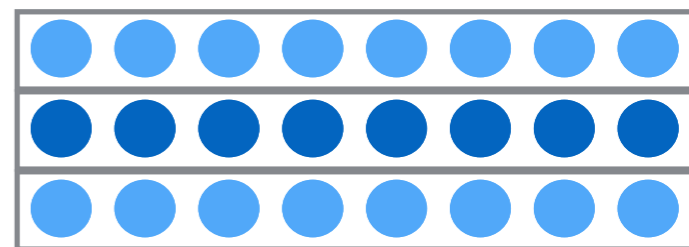

dot

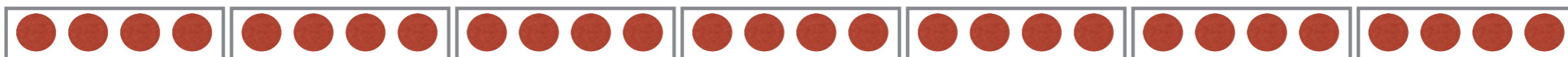

the

actual

service

was

not

very

good

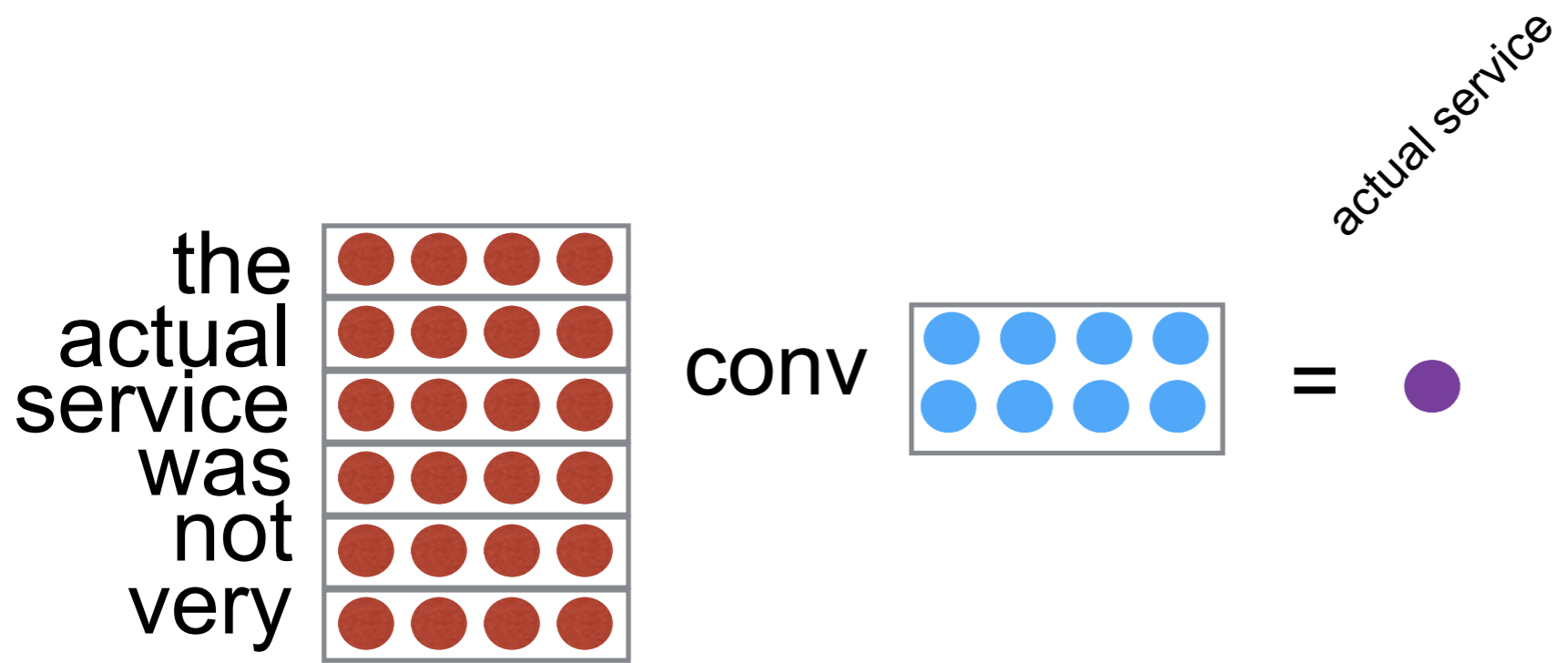

(another way to represent text convolutions)

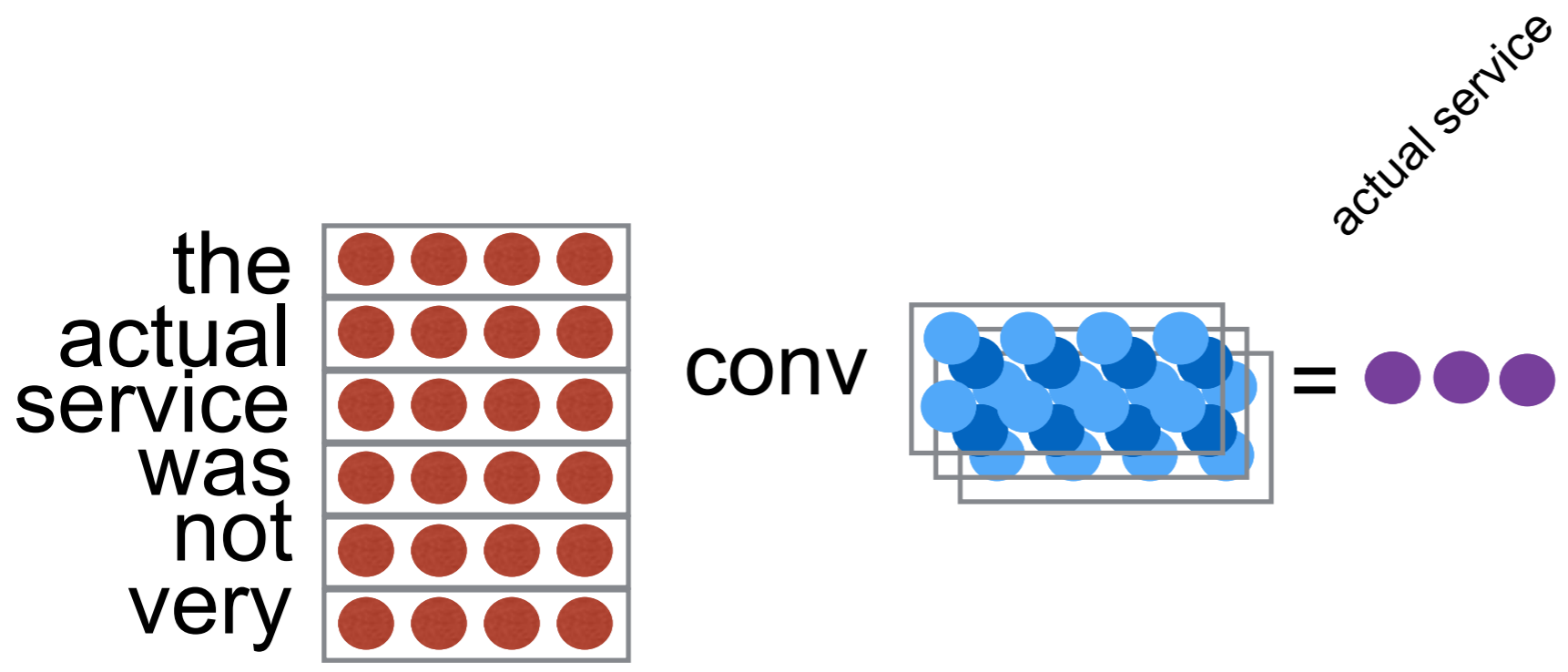

(another way to represent text convolutions)

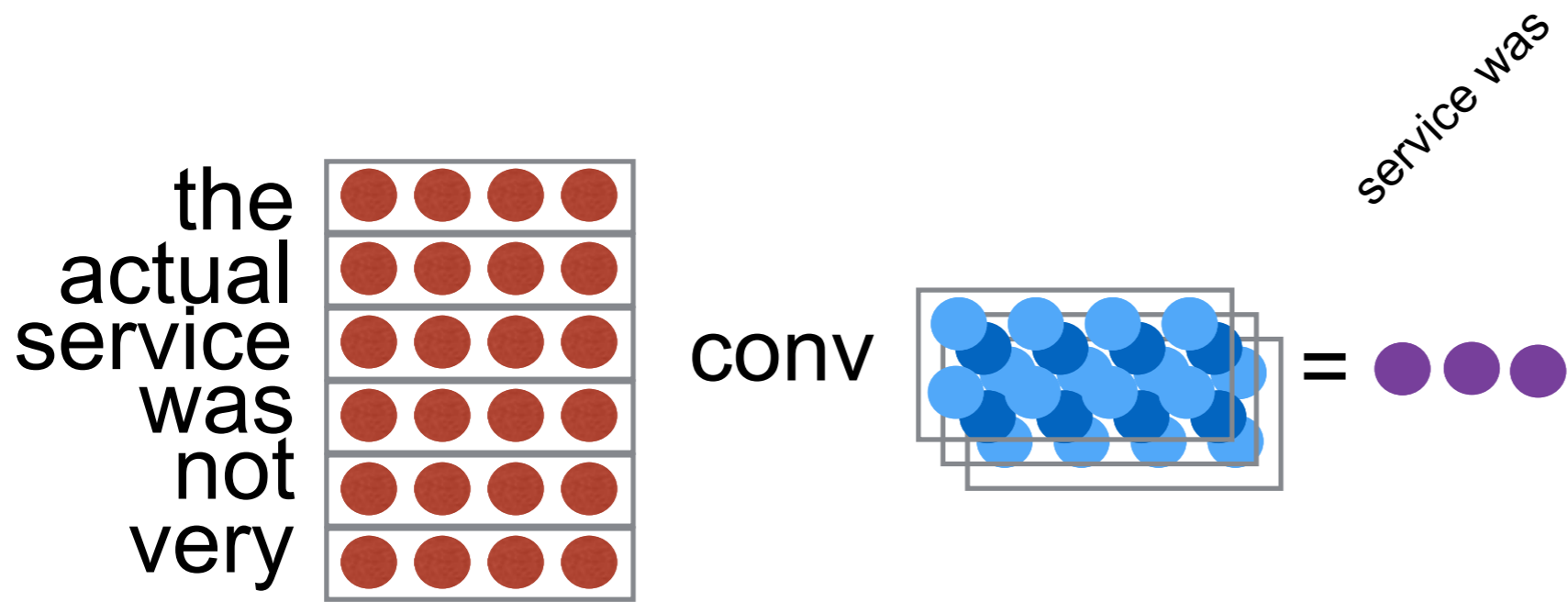

(another way to represent text convolutions)

the actual



actual service



service was



was not



not very



very good



||

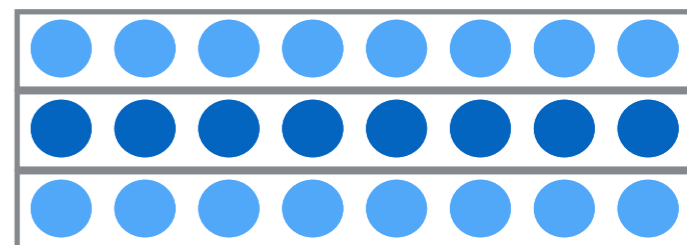

dot

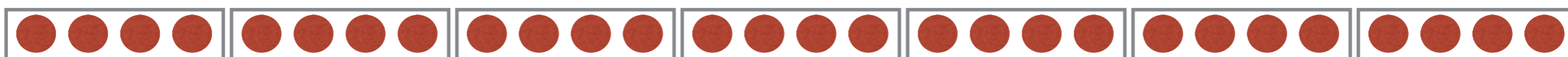

the

actual

service

was

not

very

good

**(we'll focus on the 1-d view here,
but remember they are equivalent)**

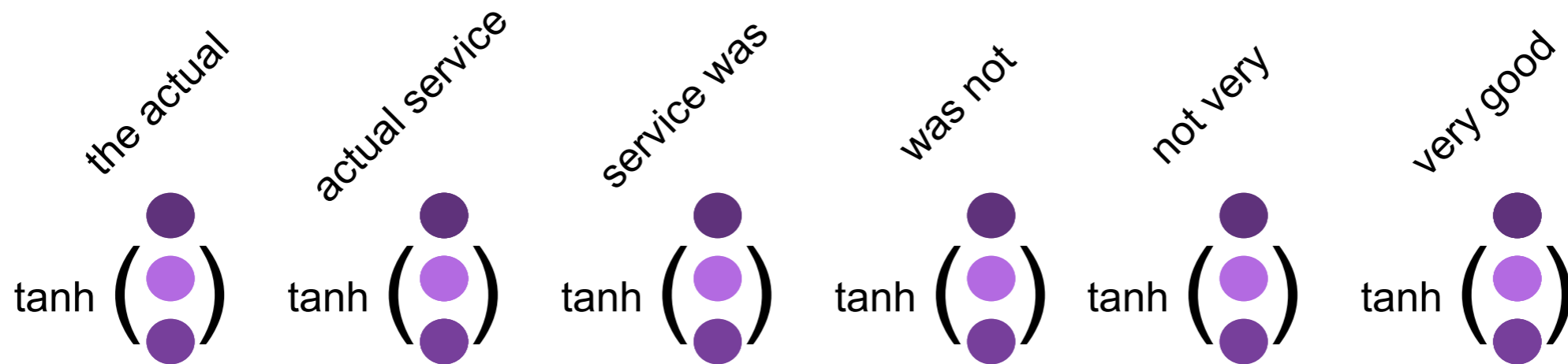

||

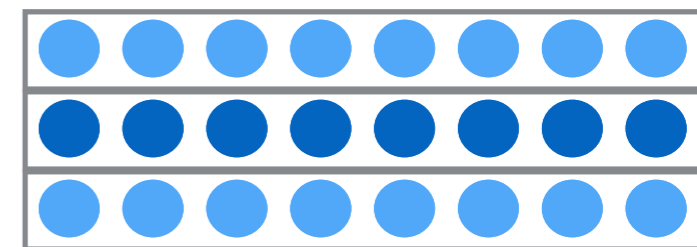

dot

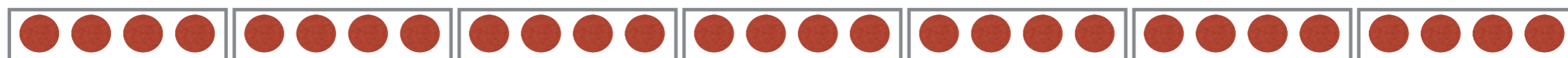

the actual service was not very good

(usually also add non linearity)

the actual

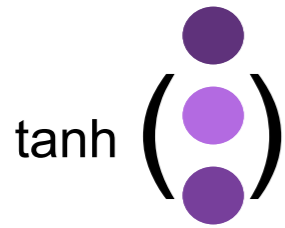

||

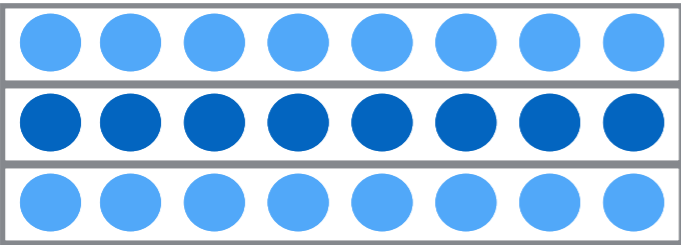

dot

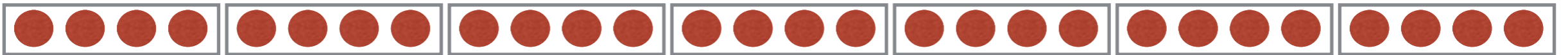

the

actual

service

was

not

very

good

(can have larger filters)

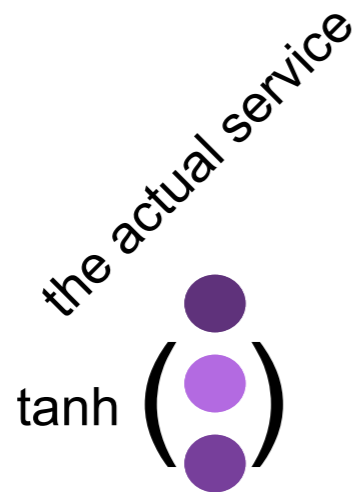

||

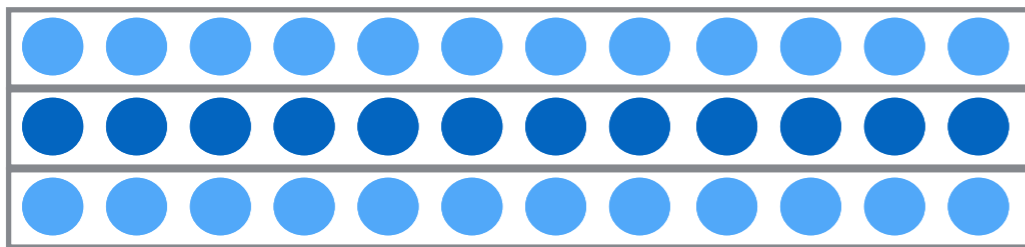

dot

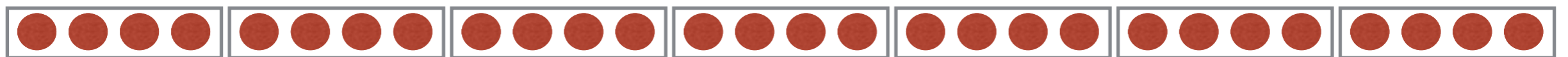

the

actual

service

was

not

very

good

(can have larger filters)

the actual



actual service



service was



was not



not very



very good

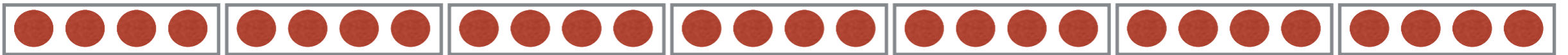

the

actual

service

was

not

very

good

we have the ngram vectors. now what?

the actual



+

actual service



+

service was



+

was not



+

not very



+

very good



=

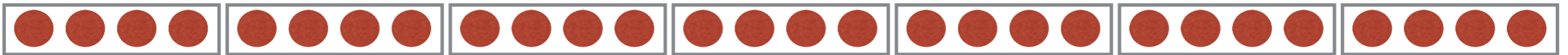

the

actual

service

was

not

very

good

can do "pooling"

"Pooling"

Combine K vectors into a single vector

"Pooling"

Combine K vectors into a single vector

**This vector is a summary of the K vectors,
and can be used for prediction.**

average pooling

average vector

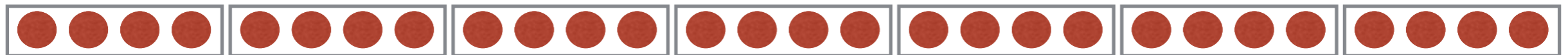
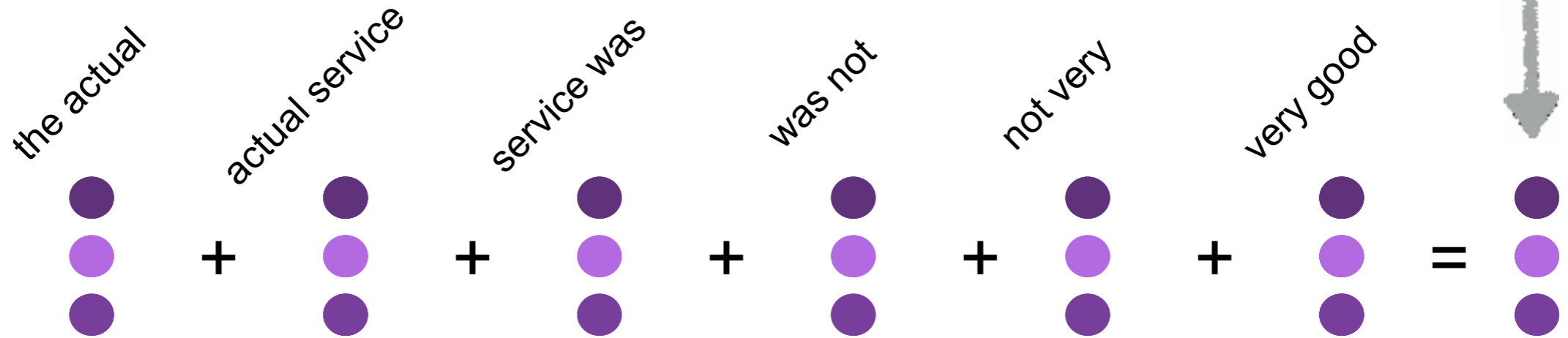

the actual service was not very good

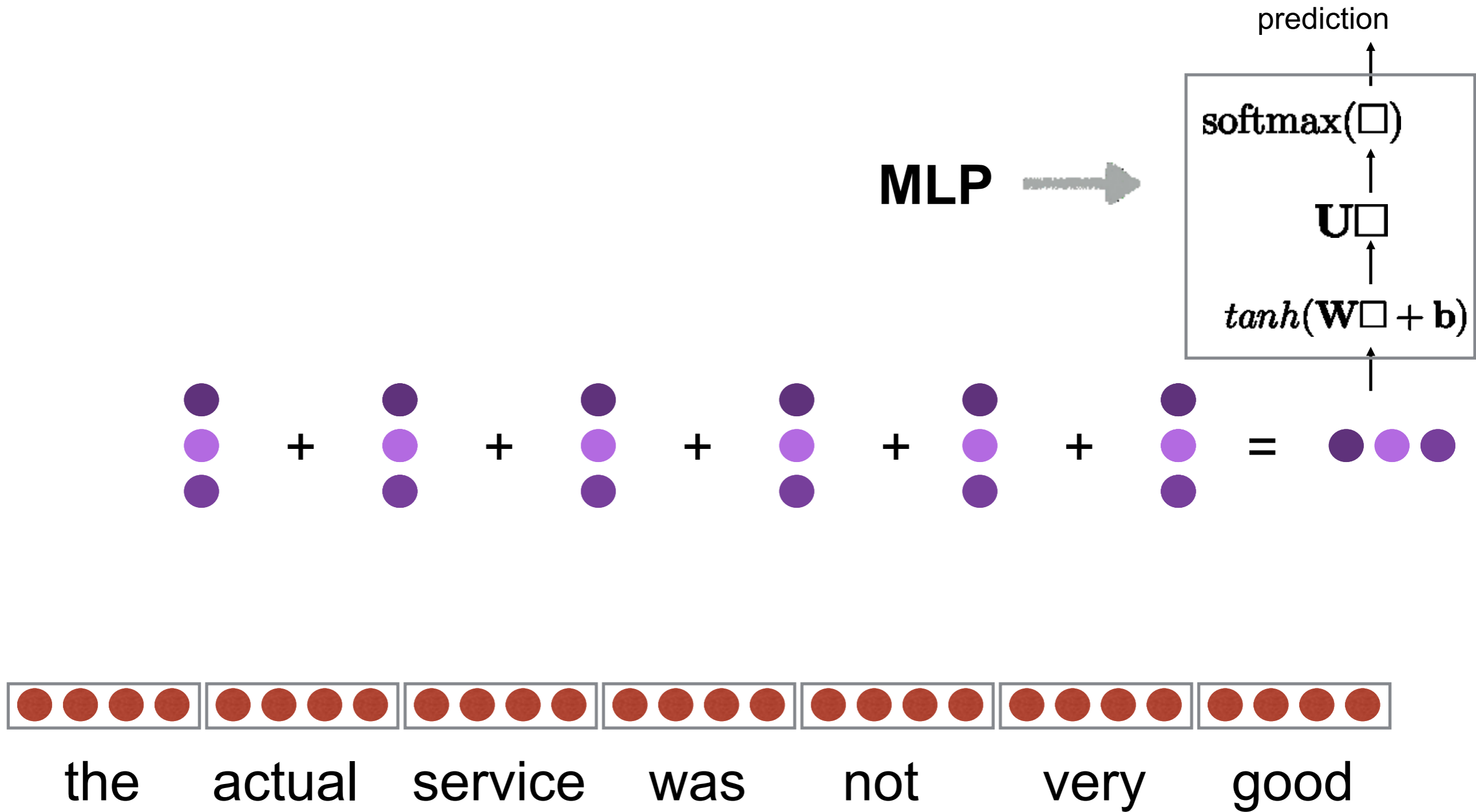

train end-to-end for some task

(train the MLP, the filter matrix, and the embeddings together)

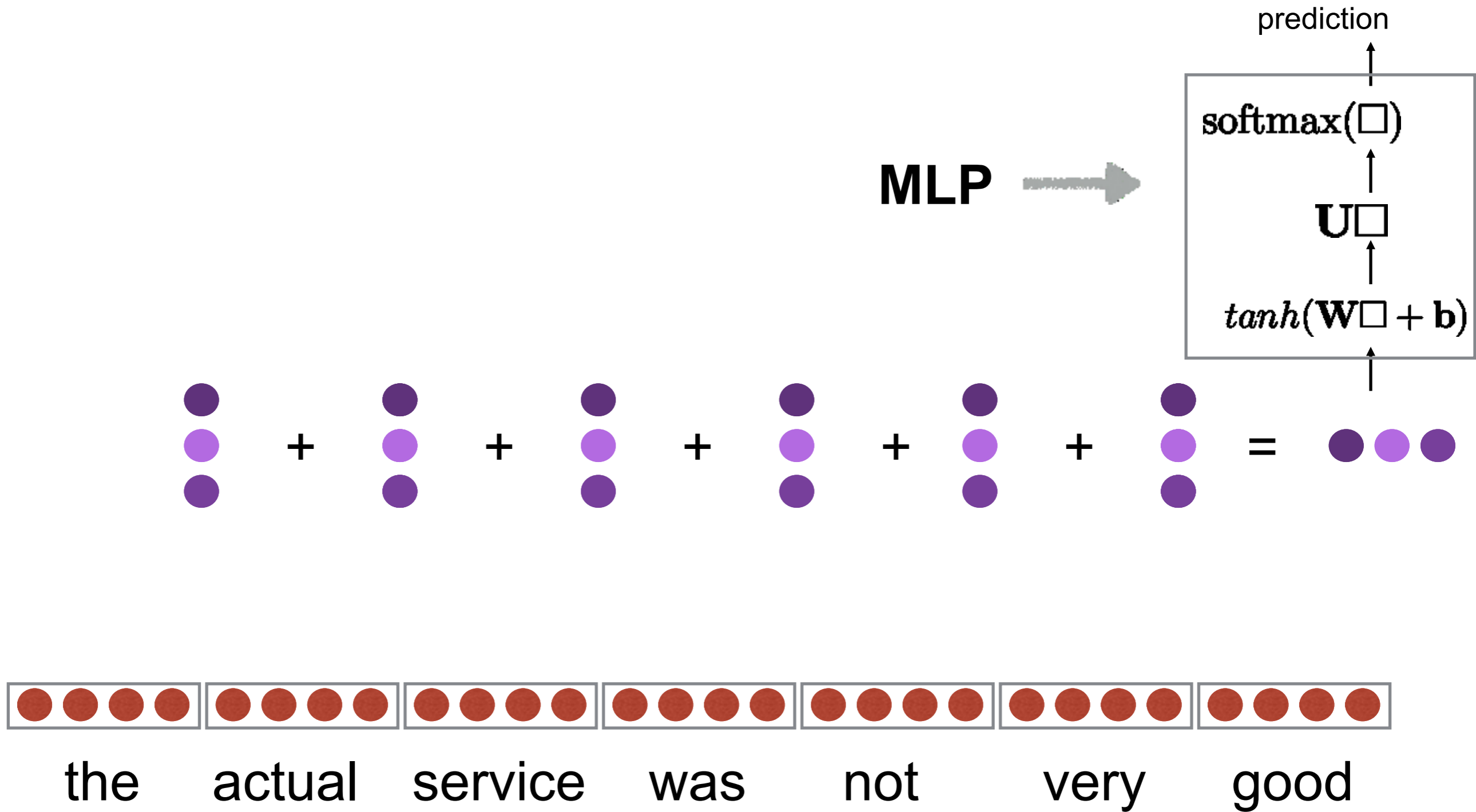

train end-to-end for some task

(train the MLP, the filter matrix, and the embeddings together)
the vectors learn to capture what's important

we have the ngram vectors. now what?

Can look at the differences between terms.

microsoft <i>office</i> software		car <i>body</i> shop	
Free <i>office</i> 2000	0.550	car <i>body</i> kits	0.698
download <i>office</i> excel	0.541	auto <i>body</i> repair	0.578
word <i>office</i> online	0.502	auto <i>body</i> parts	0.555
apartment <i>office</i> hours	0.331	wave <i>body</i> language	0.301
massachusetts <i>office</i> location	0.293	calculate <i>body</i> fat	0.220
international <i>office</i> berkeley	0.274	forcefield <i>body</i> armour	0.165

Table 2: Sample word n-grams and the cosine similarities between the learned word-n-gram feature vectors of “*office*” and “*body*” in different contexts after the CLSM is trained.

A Latent Semantic Model with Convolutional-Pooling Structure for Information Retrieval

Yelong Shen
Microsoft Research
Redmond, WA, USA
yeshen@microsoft.com

Xiaodong He
Microsoft Research
Redmond, WA, USA
xiaohex@microsoft.com

Jianfeng Gao
Microsoft Research
Redmond, WA, USA
jfgao@microsoft.com

Li Deng
Microsoft Research
Redmond, WA, USA
deng@microsoft.com

Grégoire Mesnil
University of Montréal
Montréal, Canada
gregoire.mesnil@umontreal.ca

average pooling

average vector

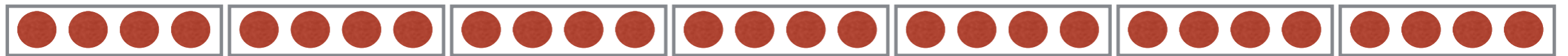
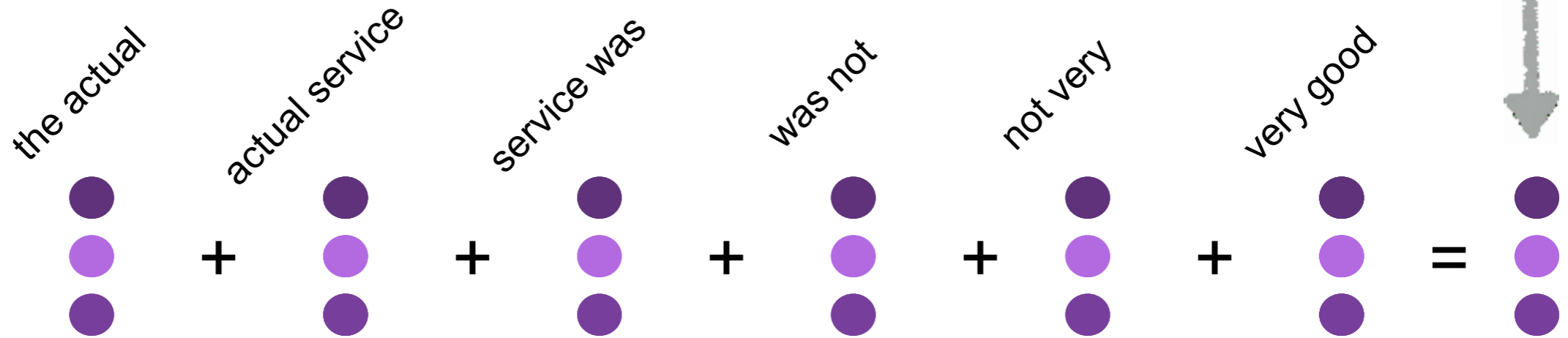

the actual service was not very good

max pooling

max vector

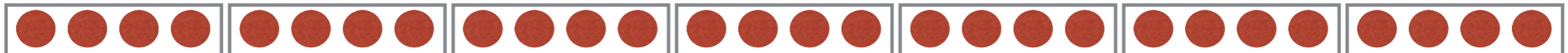
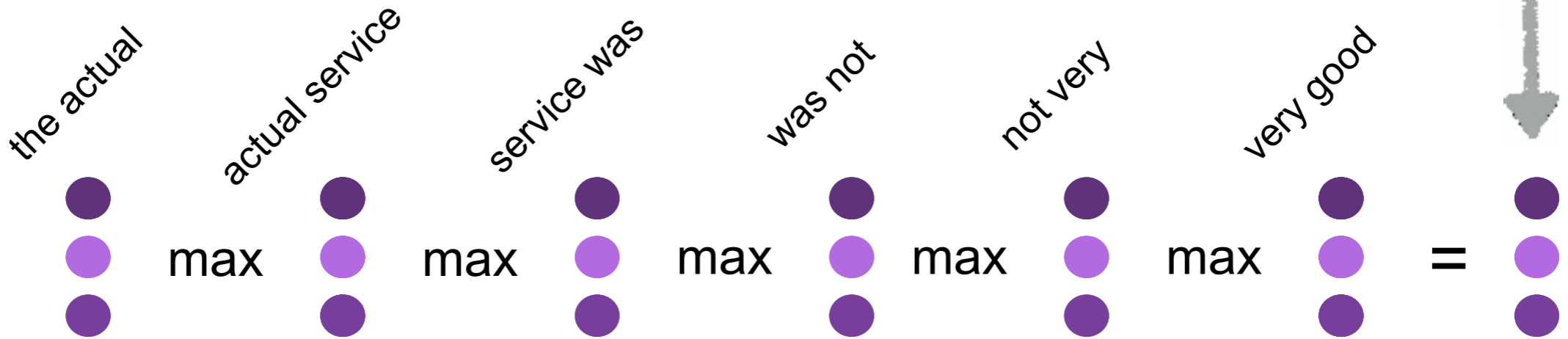

the actual service was not very good

(max in each coordinate)

Another way to draw this:

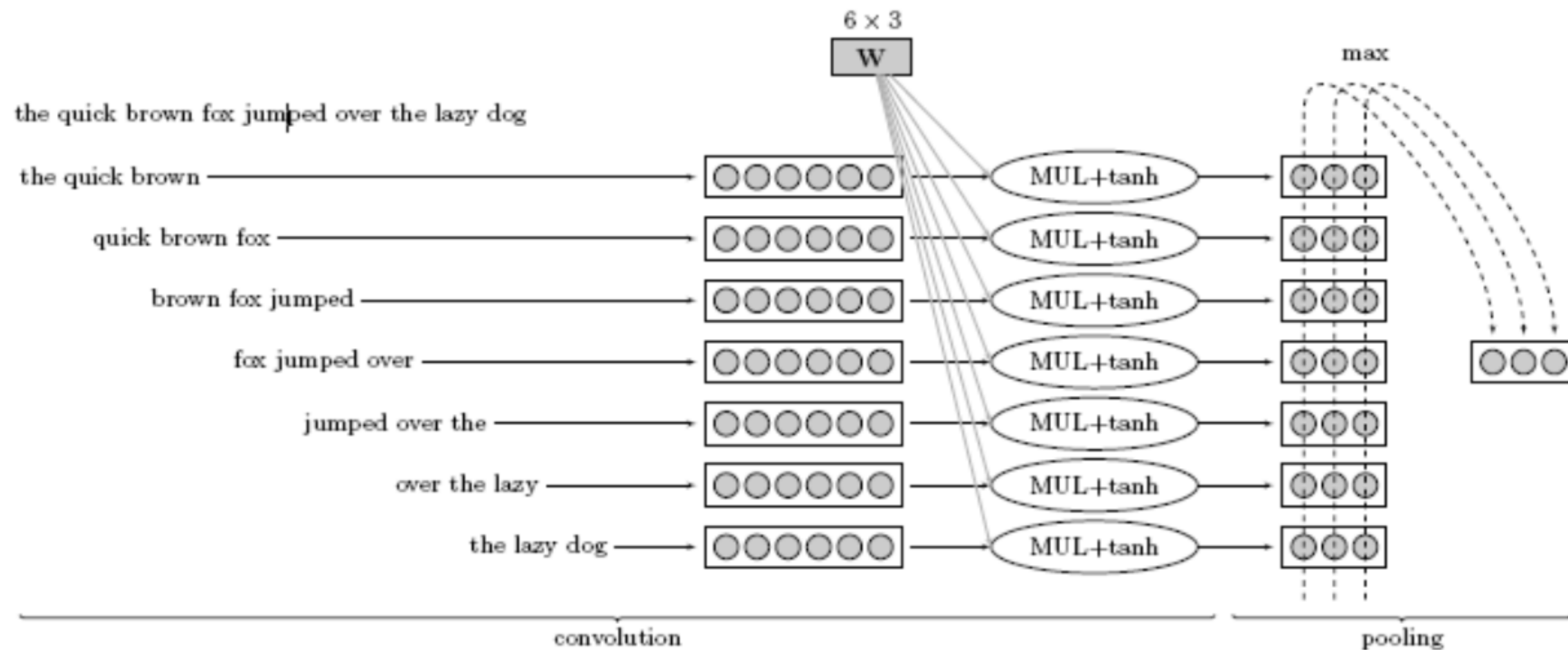

max pooling

max vector

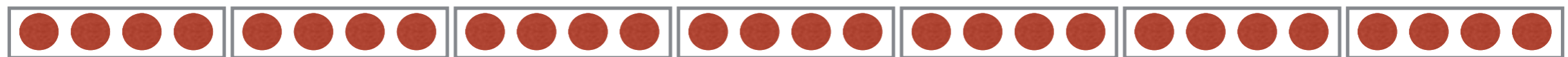
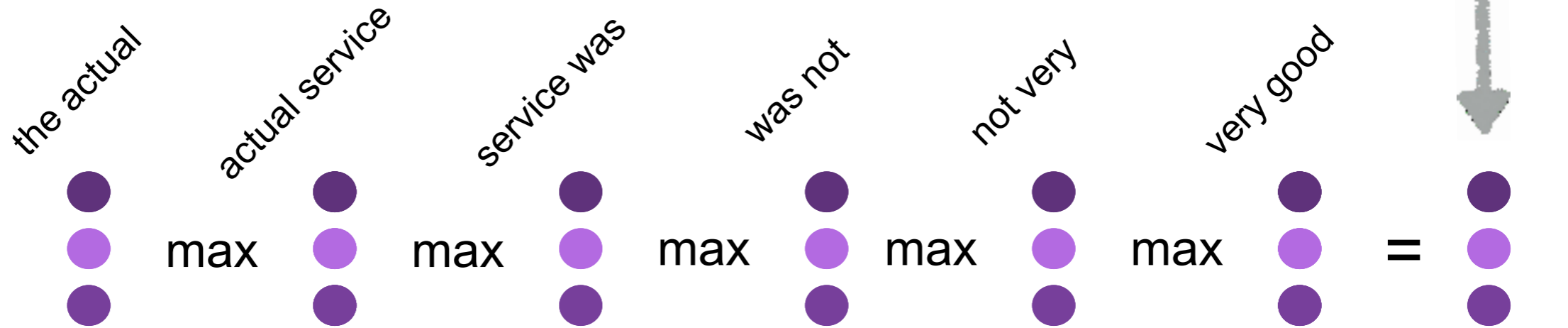

the actual service was not very good

max vs average – discuss

Zhang, Y., & Wallace, B. (2015). A Sensitivity Analysis of (and Practitioners' Guide to) Convolutional Neural Networks for Sentence Classification

one benefit of max-pooling: it's "**interpretable**"

we can know where each element
in the summary vector came from

Examples of resulting "summaries"

microsoft **office excel** could allow remote **code execution**

welcome to the **apartment office**

online **body fat** percentage **calculator**

online **auto body** repair **estimates**

vitamin a the **health** benefits given by **carrots**

calcium supplements and **vitamin d** discussion stop **sarcoidosis**

Table 3: Sample document titles. We examine the five most active neurons at the max-pooling layer and highlight the words in **bold** who win at these five neurons in the *max* operation. Note that, the feature of a word is extracted from that word together with the context words around it, but only the center word is highlighted in bold.

Strides

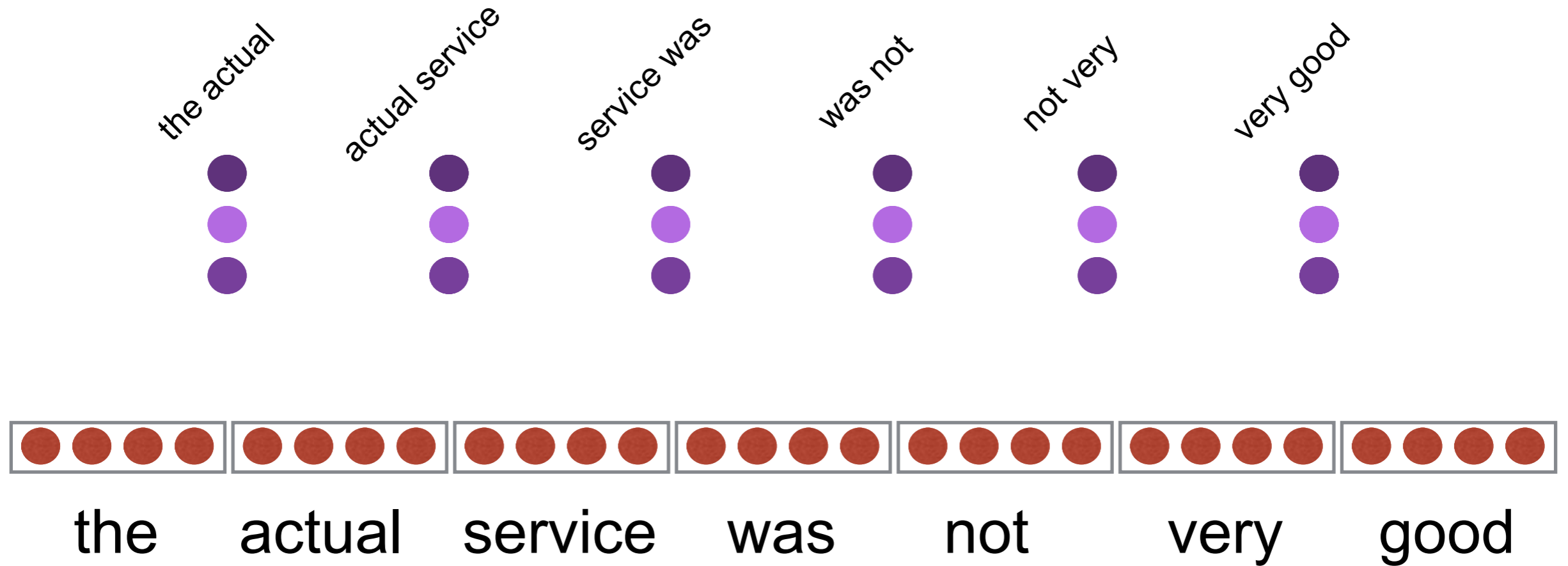

strides = how much you move

Strides

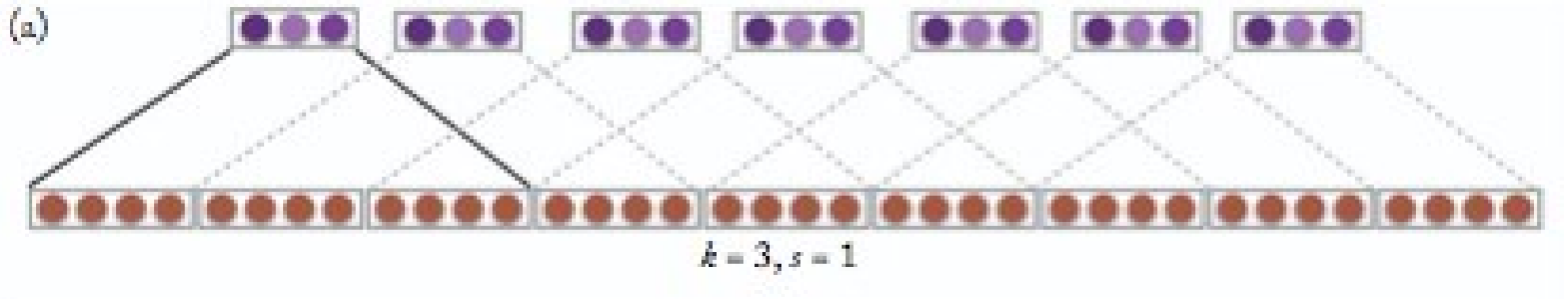

$k = 3, \text{ stride} = 1$

Strides

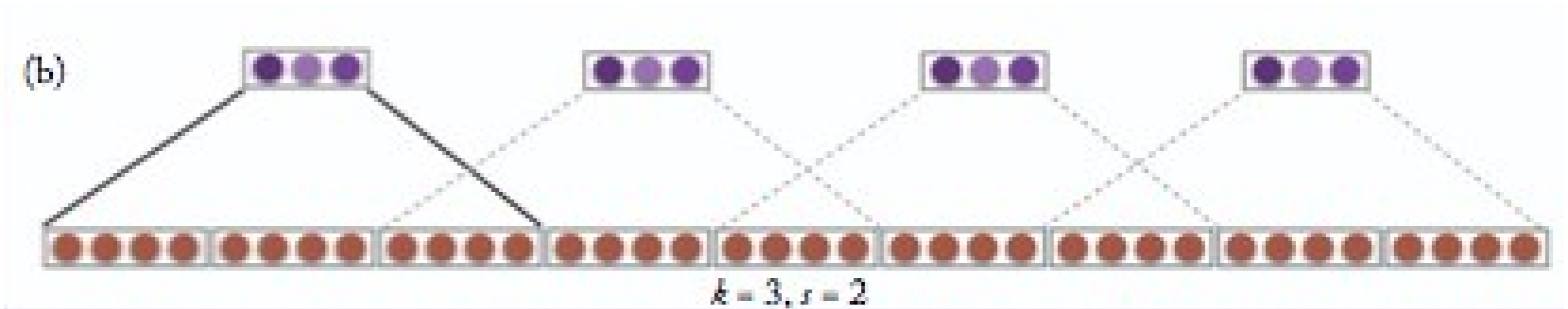

$k = 3, \text{ stride} = 2$

Strides

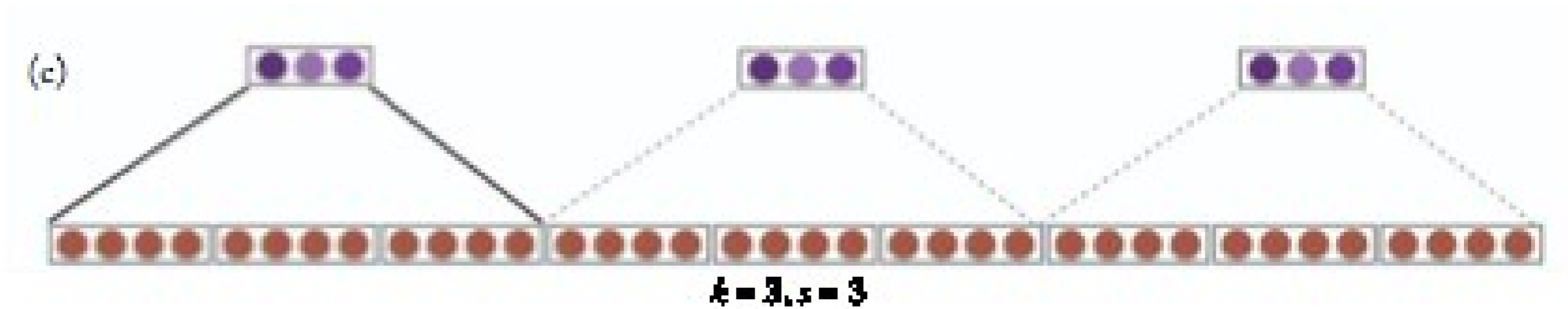

$k = 3, \text{ stride} = 3$

Hierarchy

Hierarchy



the actual



actual service



service was



was not



not very



very good

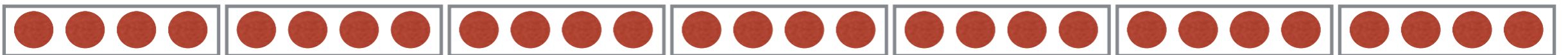

the

actual

service

was

not

very

good

can have hierarchy

the actual service



||

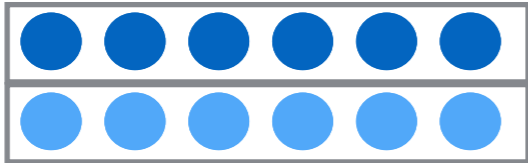

dot



the actual



actual service



service was



was not



not very



very good

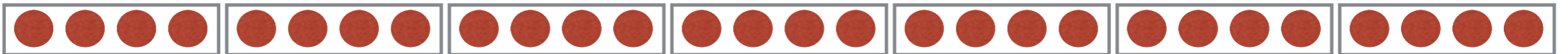

the

actual

service

was

not

very

good

can have hierarchy

●
●
||

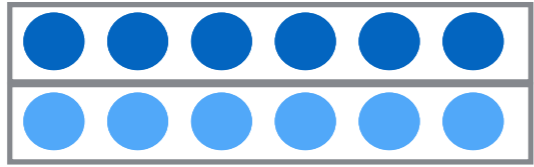

dot

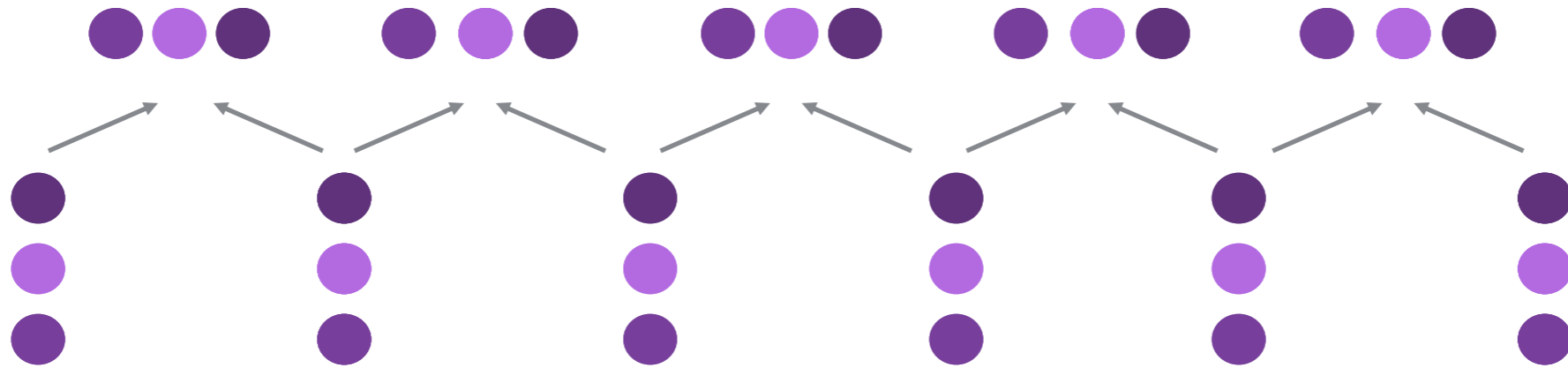

the actual service was not very good

(can combine: **pooling + hierarchy**)

Hierarchy

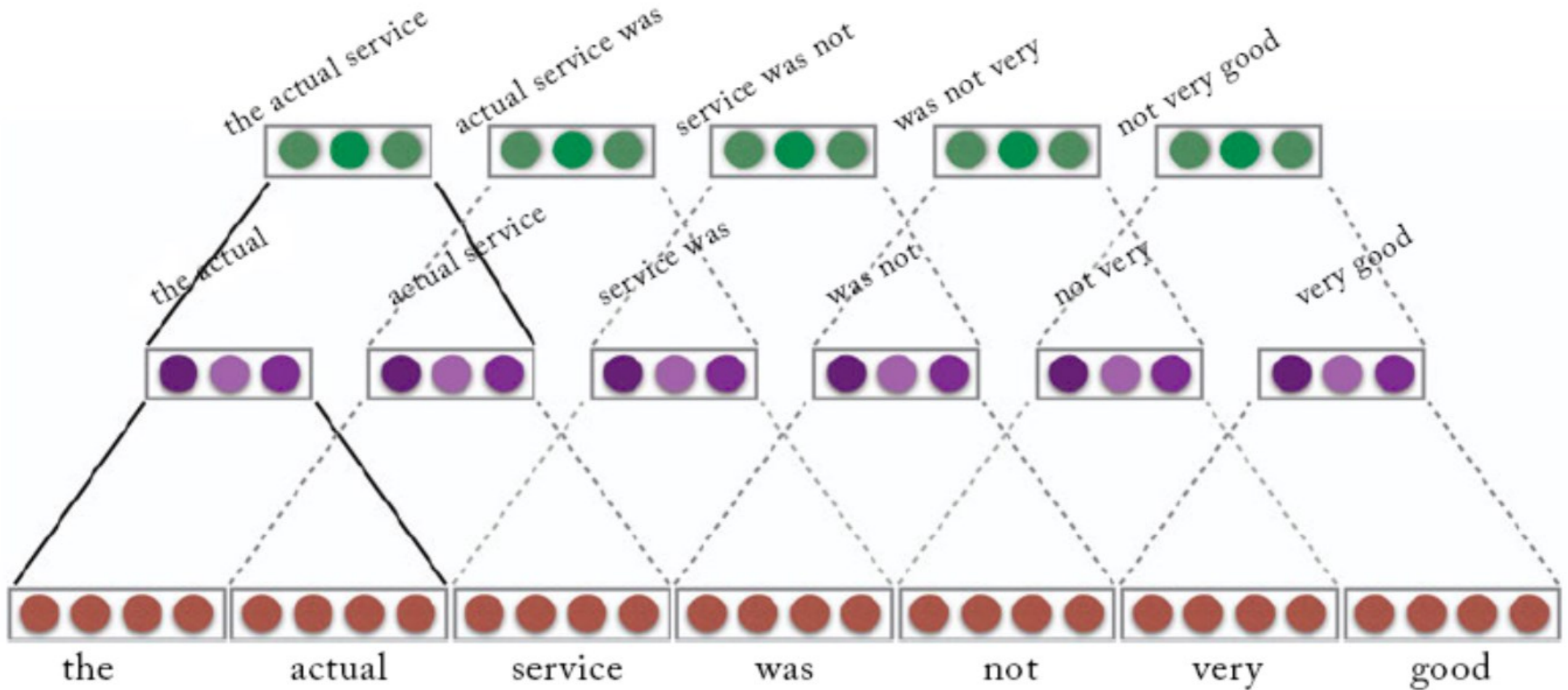

2-layer hierarchical conv with $k=2$

Dilated Convolutions

we want to cover more of the sequence

idea: strides + hierarchy

Dilated Convolutions

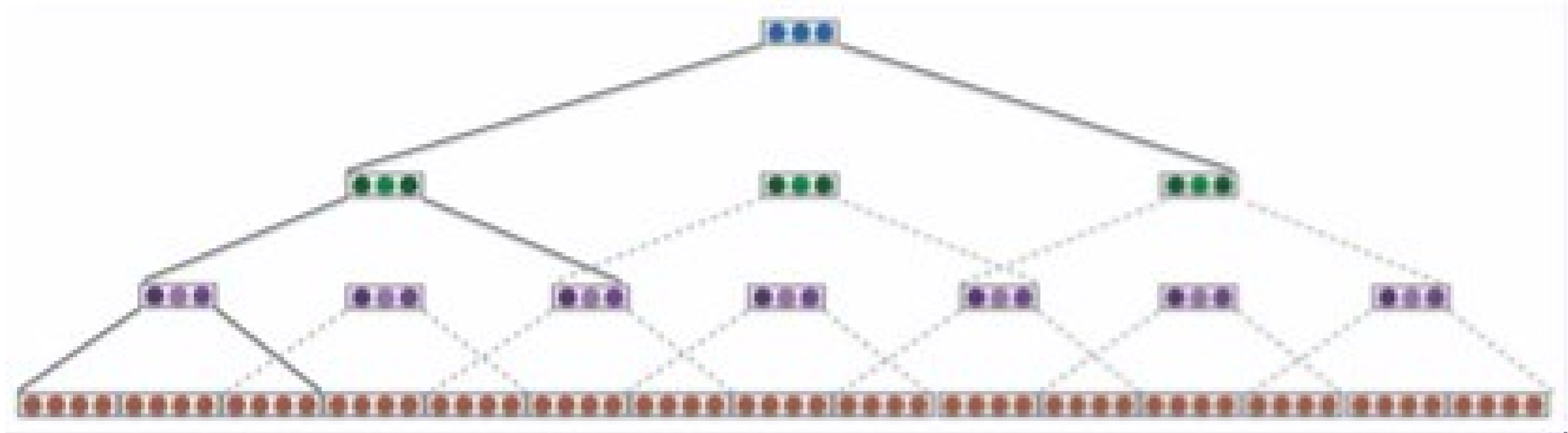

dilated convolution, $k=3$

idea: strides + hierarchy

ConvNets Summary

- Shared matrix used as feature detector.
- Extracts interesting ngrams.
- Pool ngrams to get fixed length representation.
- Max-pooling works well.
 - Max vs. Average pooling.
- Use hierarchy / dilation to expand coverage.
- Train end-to-end.

Character CNNs

- Fix the input OOV problem
 - Input: some insight in word shapes (xxxxing, xxxxly)
 - Output: can't ever output a word not in vocabulary
- Idea
 - Instead (or in addition of) word embedding
 - Use word = CNN over character sequences

Char CNN for Words

- Varied filter sizes
- Word embedding

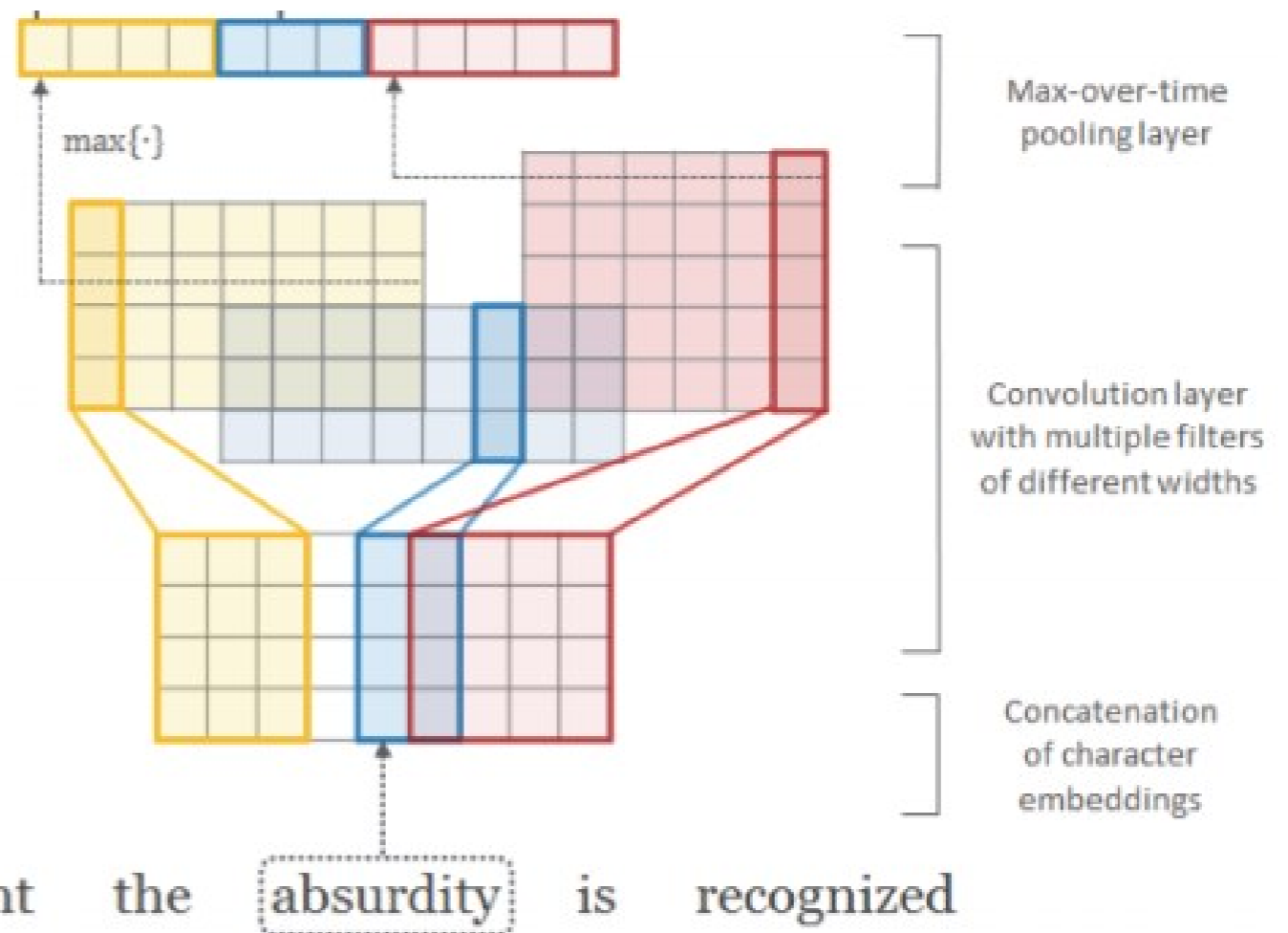

Character-Aware Neural Language Models

Yoon Kim
School of Engineering
and Applied Sciences
Harvard University
yoonkim@seas.harvard.edu

Yacine Jernite
Courant Institute
of Mathematical Sciences
New York University
jernite@cs.nyu.edu

David Sontag
Courant Institute
of Mathematical Sciences
New York University
dsontag@cs.nyu.edu

Alexander M. Rush
School of Engineering
and Applied Sciences
Harvard University
srush@seas.harvard.edu

- Can't differentiate between words w similar spellings
- Solution: add small correction $[e_w = \text{CNN}(\text{chars}_w) + M \cdot \text{corr}_w]$

Alternative: Hashing Trick

- ConvNet is an architecture for finding good ngrams.
- But if we know ngrams are important, why not just have ngram embeddings (ngram vectors)?
- --> for large vocabulary, not scalable.

Can't represent all ngrams, don't know which are important.

Alternative: Hashing Trick

- **Problem:** our ngram vocabulary size is 10^9
- **Solution:** use smaller space via hashing, allow feature clashes.

Hashing Trick

- We have $> 10^9$ different ngrams.
- We can afford $\sim 10^6$ different embeddings.
- Map each ngram to a number in $[0, 10^6]$
- Use the corresponding embedding vector.
- Clashes will happen, but it will probably be ok.
- Even safer: map each ngram to two numbers using two different hash functions, sum the vectors.

Hashing Trick vs ConvNets

- What are the benefits of using bag of ngrams?
- What are the benefits of using ConvNet (ngram detector)?
- Does it matter if the vocabulary size is small or large?

(discuss)

Multi-task Learning

(time permitting)

The pitch

- Different NLP prediction tasks have shared structures.
- Hints for predicting A may help to predict B.
- Instead of training a network to do one thing, train it to do several things.
- YOU ARE ALL WINNERS

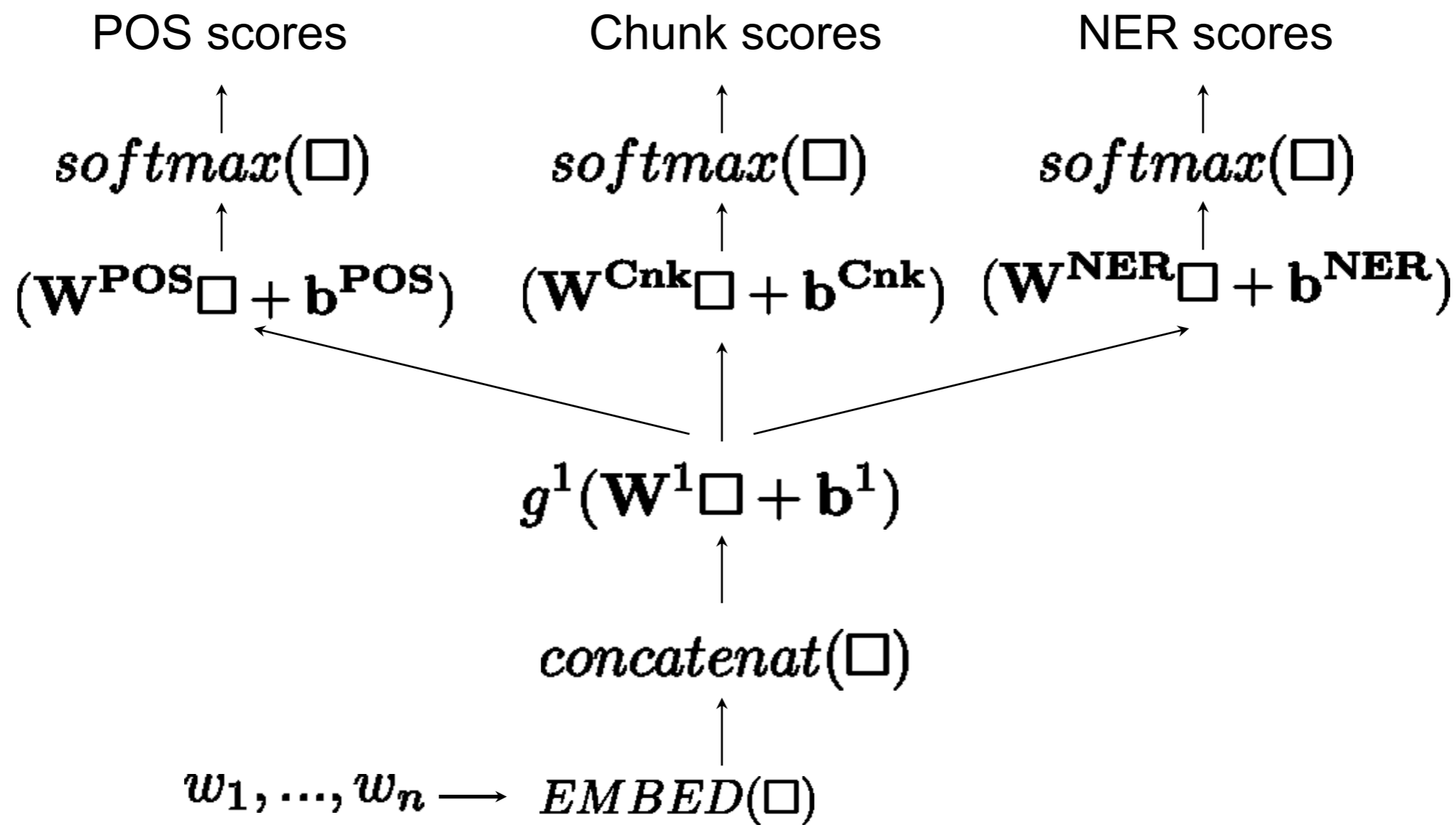

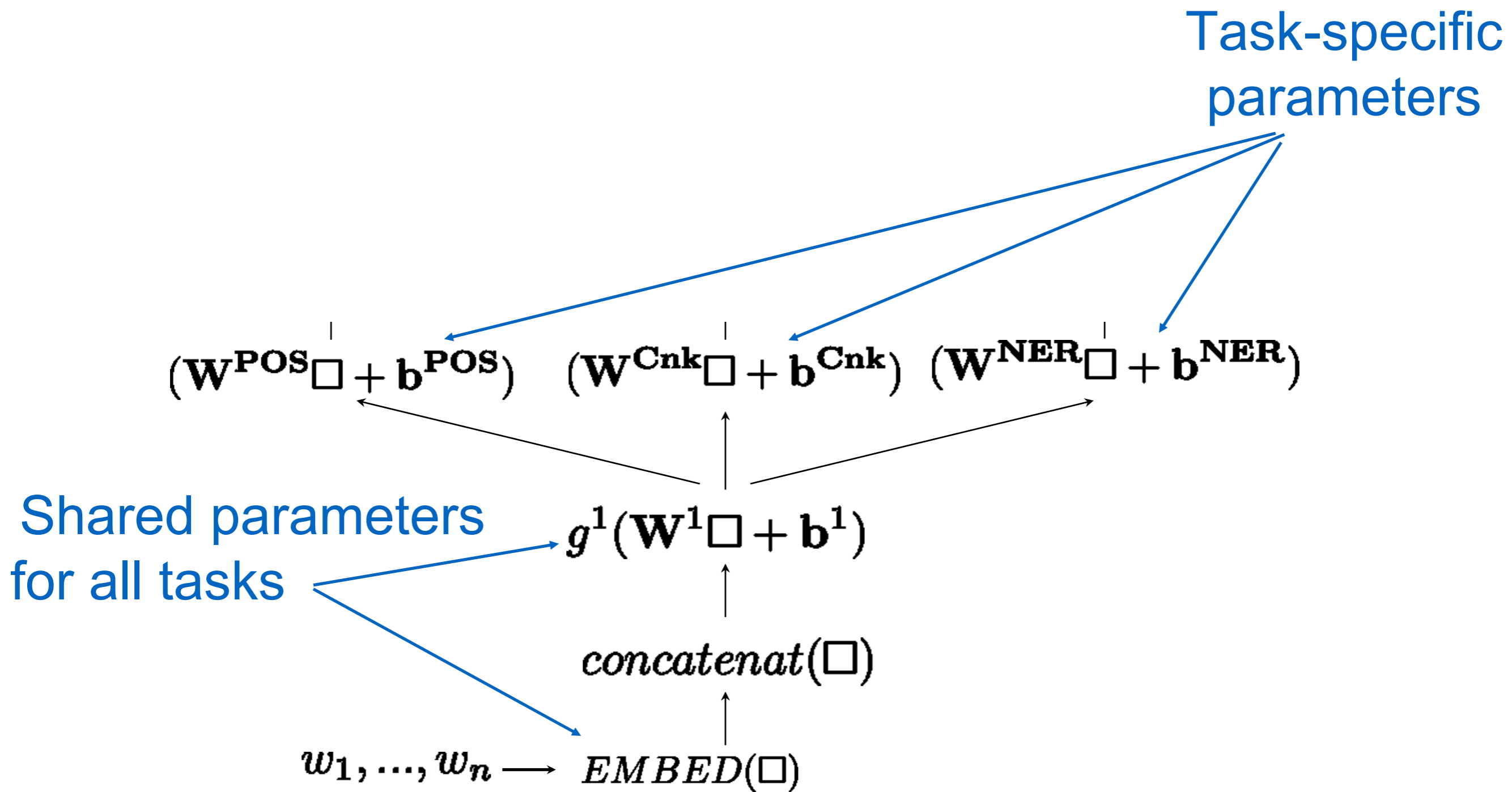

Multi-Task Learning

